

# 6 DEALER MANUAL FOR H500 (RM G062.750/1000.D)

---



## CONTENT

---

<b>6.1 Introduction</b> .....	<b>2</b>	<b>6.3 Drive Unit Installation</b> .....	<b>4</b>
<b>6.2 Specifications</b> .....	<b>2</b>	6.3.1 List of Tools to be used.....	4
6.2.1 Outline and geometric size.....	3	6.3.2 Motor Installation.....	4
6.2.2 Surface.....	3	<b>6.4 Maintenance</b> .....	<b>5</b>
6.2.3 Storage Information.....	3		

# 6.1 INTRODUCTION



- **Product Model**

RM G062.750.D

RM G062.1000.D

- **Scope**

**i** Applies only to electrically powered pedelecs developed or licensed by Bafang. It is suitable for fat bikes or all terrain bikes, which have been developed for off road on gravel or sand use. The engine is not suitable for sport competitions.

- **Identification**

The following graphic, is the identification numbers of the product, which are shown on the housing:

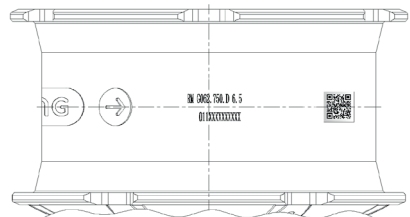

**Note:** Content in the label is important information about this product. Please do not remove the information from the motor.

# 6.2 SPECIFICATIONS

Motor model: RM G062.750.D / RM G062.1000.D

Rated power (W)	750 / 1000
Rated voltage (V)	48
Waterproof	IP65
Certification	CE - EMC
Outdoor Temperatures	-20 C ~45 C

## 6.2.1 Outline and geometric size

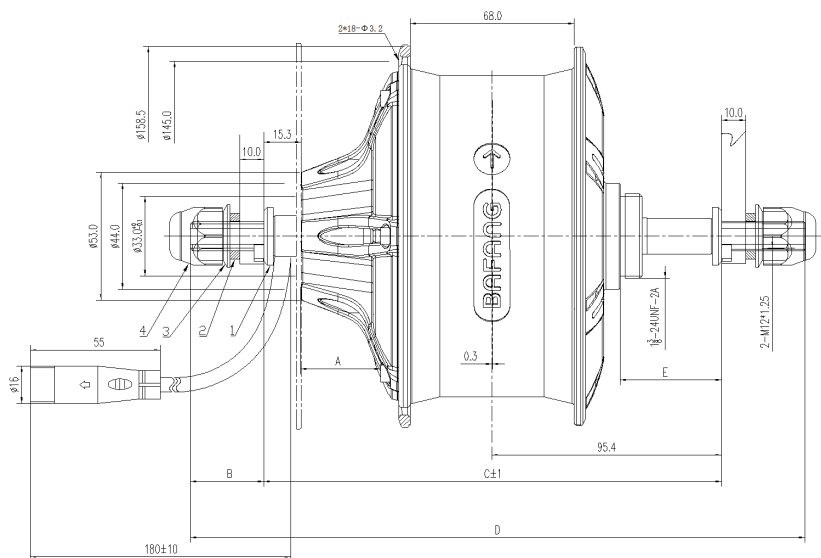

Model	A(mm)	B(mm)	C(mm)	D(mm)	E(mm)
RM G062.750.D	22	29	175	233	42.2
	33	32.5	190	255	42.2
RM G062.1000.D	22	29	175	233	42.2
	33	32.5	190	255	42.2

Motor cable length: L=250mm

## 6.2.2 Surface

Shockproof black coating

## 6.2.3 Storage Information

The pedelec should be stored in a ventilated dry room. Avoid storing the pedelec near strong magnetic objects.

# 6.3 DRIVE UNIT INSTALLATION

## 6.3.1 List of Tools to be used

### Use of the Tools

To tighten/loosen the M5\*8 screws onto the disc brake.



### Tools

Internal hex wrench

To tighten/loosen the M12 flange nuts.



Open spanner

## 6.3.2 Motor Installation

1. Mount the cassette on the motor.

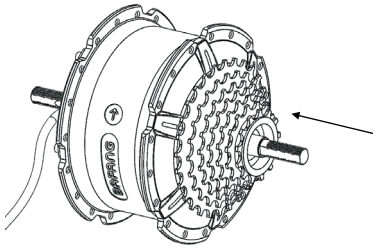

2. First place the disc brake on to the motor and tighten with six M5\*8 screws.

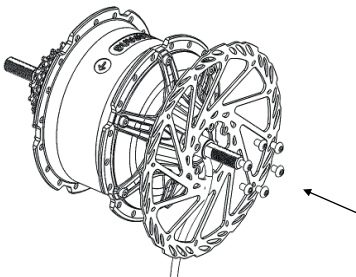

3. Mount the stop pin into on the shaft.

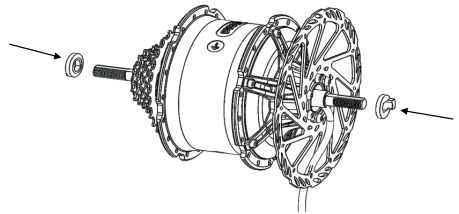

4. Insert the motor into the frame.

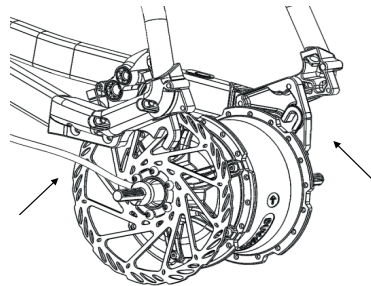

5. Mount the 2mm washer on both sides of the frame.

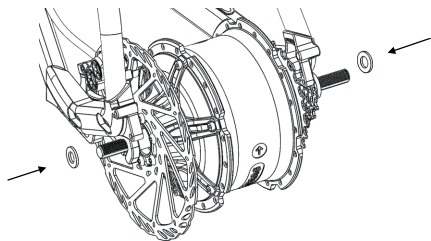

6. Tighten the flange nuts with open spanner at both sides of the motor. (torque requirement: 47-60 N.m.)

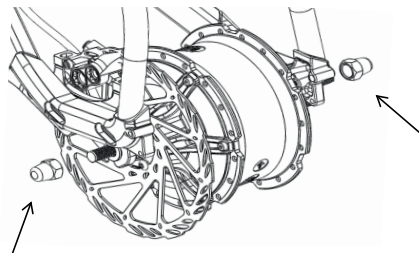

## 6.4 MAINTENANCE

- Maintenance must be carried out by authorized personnel with the correct equipment.
- Do not disassemble the motor.
- Do not use thinners or other solvents to clean the components. Such substances can damage the surfaces.
- Avoid water submerging, to keep the components protected.
- Avoid using high-pressure cleaning jets.
- For prolonged storage, turn off the battery and avoid storing near heat sources.

