

6 DEALER MANUAL FOR H600 (FM G370.250.D)



CONTENT

6.1 Introduction	2	6.3 Drive Unit Installation	4
6.2 Specifications	3	6.3.1 List of Tools to be used.....	4
6.2.1 Outline and geometric size.....	3	6.3.2 Motor Installation.....	4
6.2.2 Surface.....	3	6.4 Maintenance	5
6.2.3 Storage Information.....	3		

6.1 INTRODUCTION



- **Product Model**

FM G370.250.D

- **Scope**

i Applies only to electrically powered pedelecs developed or licensed by Bafang. It is suitable for city, trekking and road bikes, which have been developed for road use. The engine is not suitable for sport competitions.

- **Identification**

The following graphic, is the identification numbers of the product, which are shown on the housing:

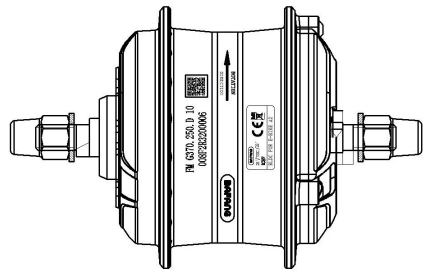

Note: Content in the label is important information about this product. Please do not remove the information from the motor.

6.2 SPECIFICATIONS

Motor model: FM G370.250.D

Rated power (W)	250
Rated voltage (V)	36 / 43
Waterproof	IP65
Certification	CE
Outdoor Temperatures	-20 °C~45 °C

6.2.1 Outline and geometric size

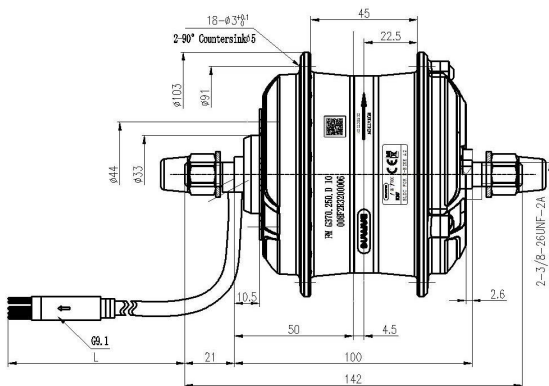

OLD: 100mm

Shaft length: 142mm

Motor cable length: $L=250$ mm (optional)

6.2.2 Surface



Shockproof black and silver coating

6.2.3 Storage Information

The pedelec should be stored in a ventilated dry room. Avoid storing the pedelec near strong magnetic objects.

6.3 DRIVE UNIT INSTALLATION

6.3.1 List of Tools to be used

Use of the Tools	Tools
To fasten BC3/8 cap lock-nuts	 Open-end wrench
To fasten the screws on disk brake	 Internal hexagonal wrench

6.3.2 Motor Installation

1. First place the brake disc on to cable side of the motor and tighten with six M5*8 screws. Insert the 0.5mm washer and stop pin on to the shaft at non-cable side.

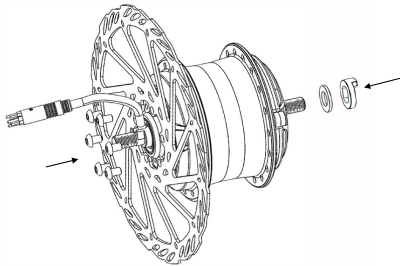

2. Insert the motor into the frame.

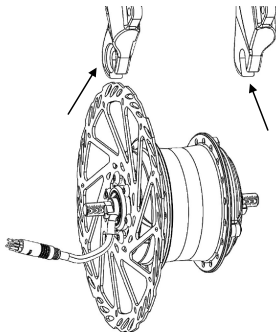

3. Mount one 2mm washer on both sides of the frame.

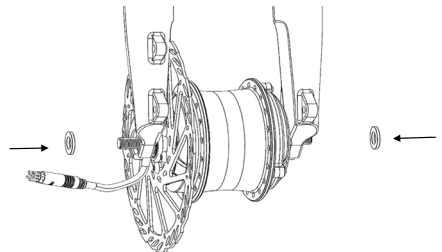

4. Fasten clockwise BC3/8 cap lock-nuts with open-end wrench at both ends of the motor. Torque requirement: 30-36N.m.

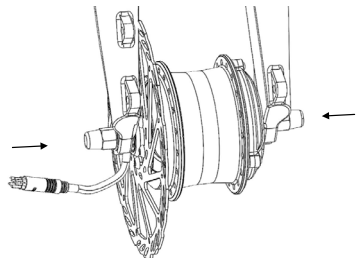

6.4 MAINTENANCE

- Maintenance must be carried out by authorized personnel with the correct equipment.
- Do not disassemble the motor.
- Do not use thinners or other solvents to clean the components. Such substances can damage the surfaces.
- Avoid water submerging, to keep the components protected.
- Avoid using high-pressure cleaning jets.
- For prolonged storage, turn off the battery and avoid storing near heat sources.

